

3. OVERALL DIMENSIONS

0 489 41/44

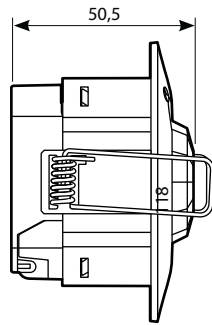

0 489 48

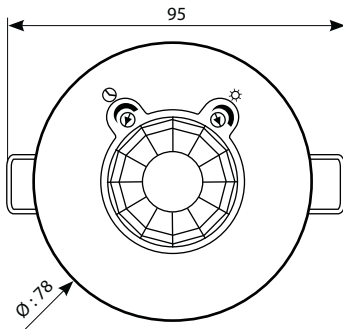
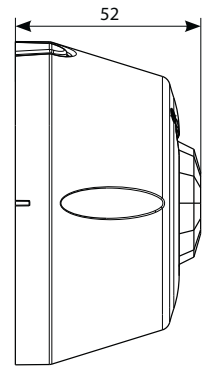
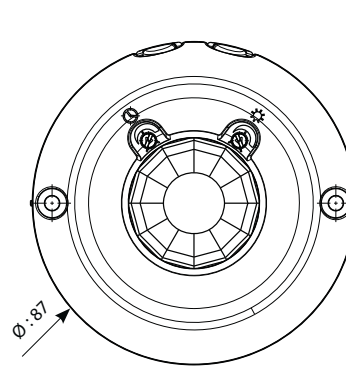

4. CONNECTION

■ 4.1 Wiring without auxiliary control:

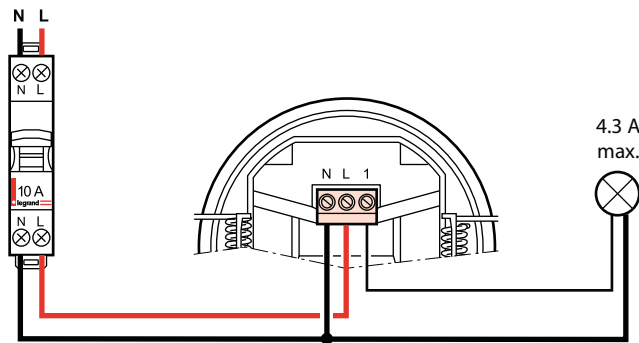

■ 4.2 Wiring for a single load connected in parallel

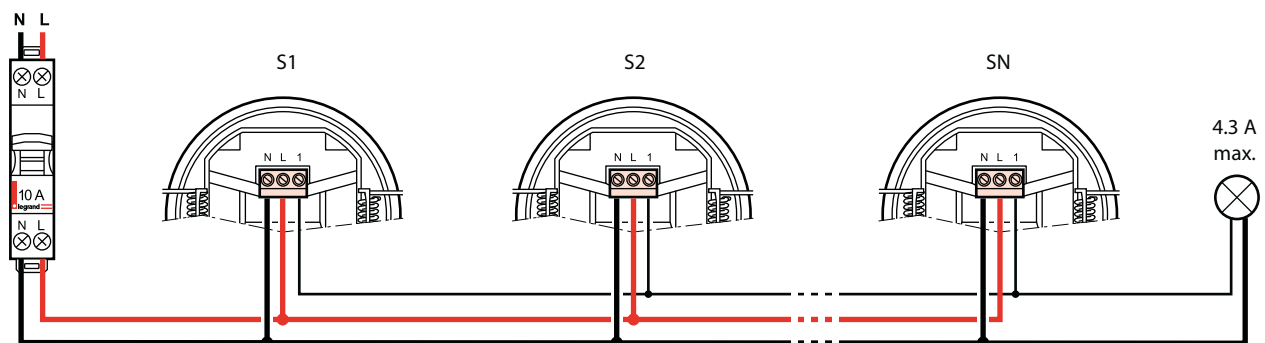

5. INSTALLATION

■ 5.1 Positioning the sensor

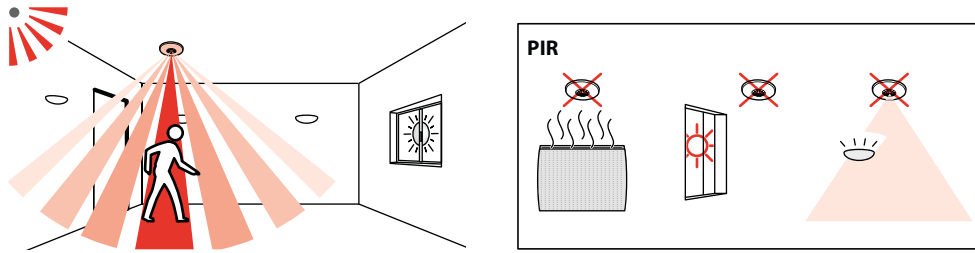

■ 5.2 Positioning

0 489 41/44

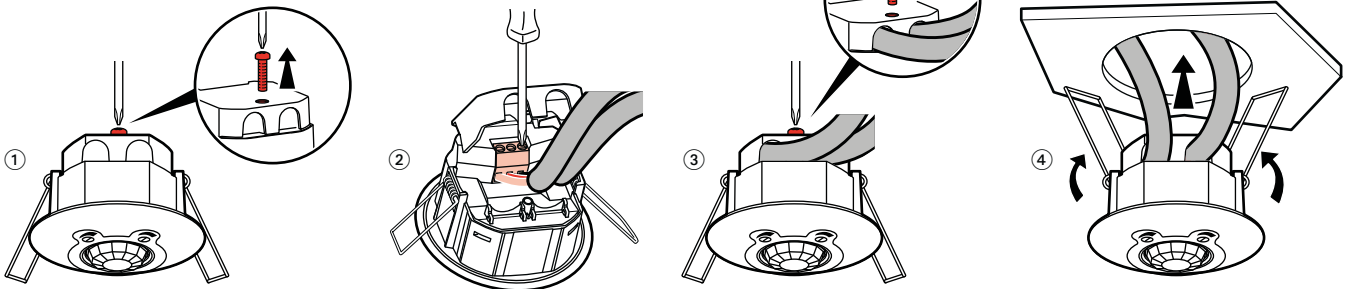
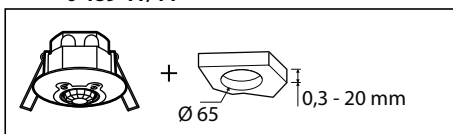

0 489 48

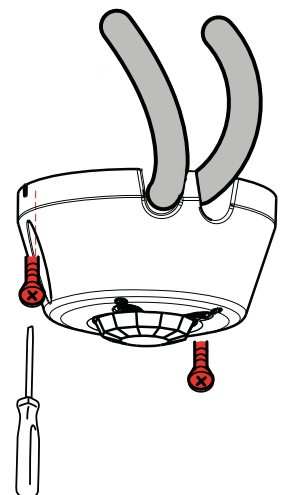
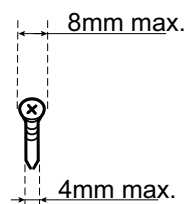
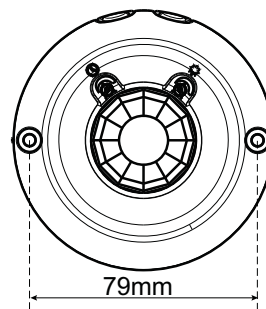
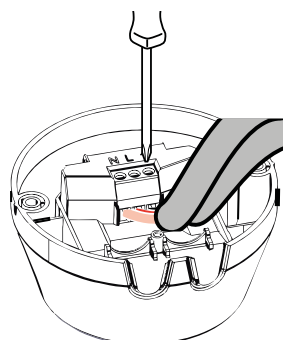
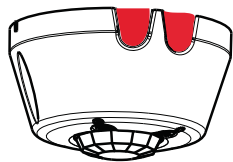

6. SETTING

■ **6.1 Time delay parameter**

Sensor parameter	Default value	Modifiable parameters
Time delay	Min.	10 sec to 10 min

⌚ **Time delay:** Length of time the load remains on after detection.

■ **6.2 Light level parameter**

Sensor parameter	Default value	Modifiable parameters
Light level threshold	Max.	10 to 1275 lux

☀ **Light level threshold:** Value at which the load switches on if the natural light level is below the setting.

■ **6.3 Detection**

Automatic switch-on:
 - On detection of presence, if there is an insufficient natural light level.
 Automatic switch-off:
 - If no presence is detected and at the end of the set time delay.
 Any new detection triggers automatic switch-on if there is insufficient light.

7. PERFORMANCE

■ **7.1 Tangential movement**

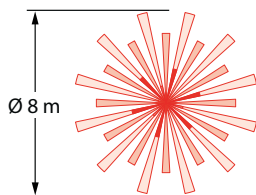
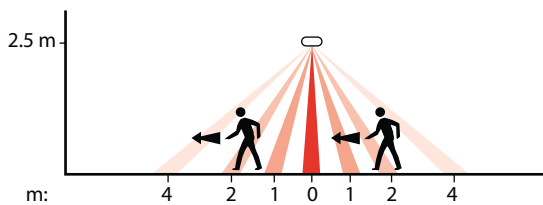

■ **7.2 Radial movement**

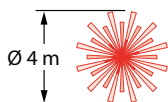
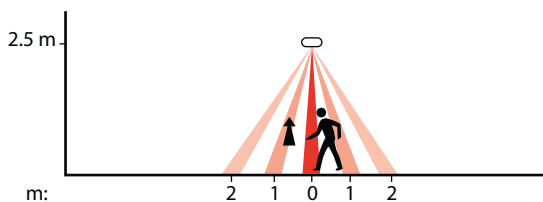

8. MAINTENANCE

Keep the lens clean.
 Clean the surface with a cloth.
 Do not use: acetone, tar-removing cleaning agents or trichloroethylene.
 Maintenance with the following products: - Hexane (En 60669-1)
 - Methylated spirit
 - Soapy water
 - Diluted ammonia
 - Bleach diluted to 10%
 - Window cleaning products

Attention:

Always test before using other special cleaning products.

9. STANDARDS

Directive: CE
 Product standards: IEC 60669-2-1
 Environmental standards:
 - EU Directive 2002/96/EC:
 WEEE (Waste Electrical and Electronic Equipment)
 - EU Directive 2002/95/EC:
 RoHS (Restriction of Hazardous Substances)

Note:

All technical information is available at

